

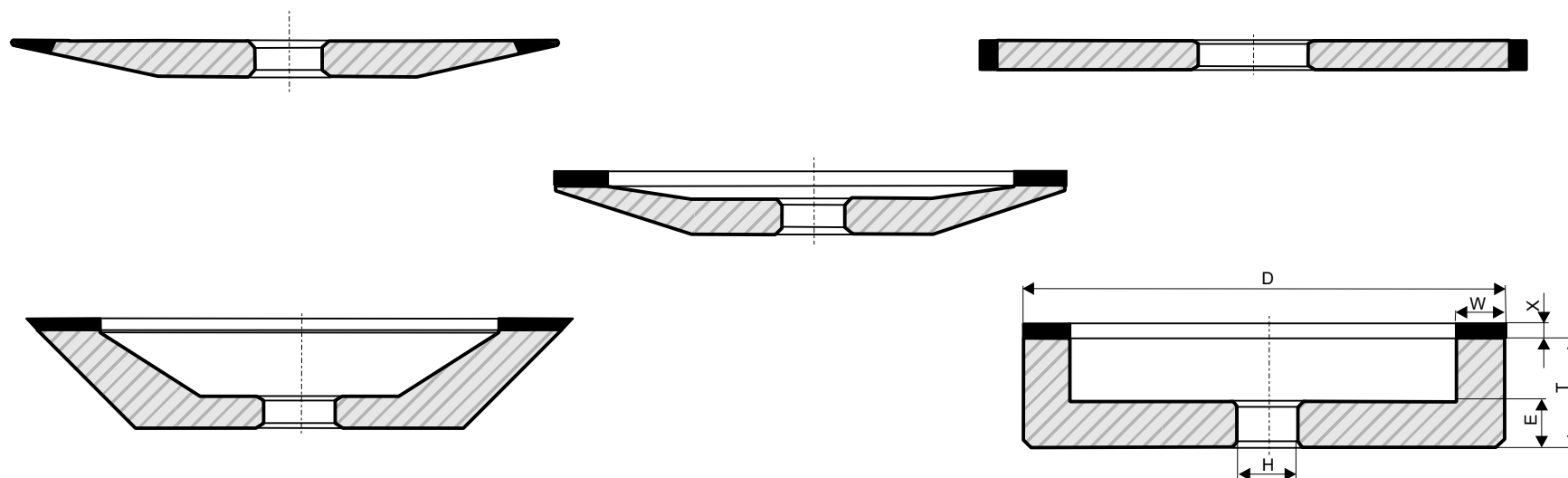

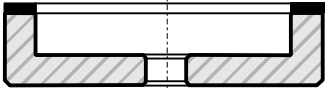

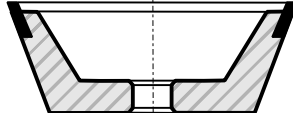

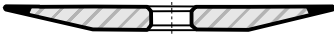

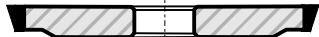
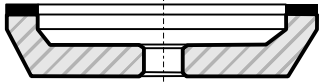
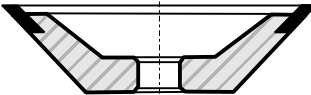

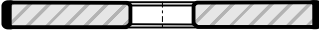
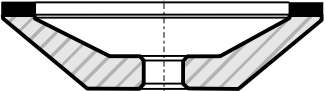
Diamantové a CBN brousící kotouče na opracování kovů

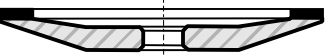
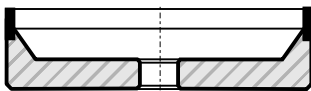
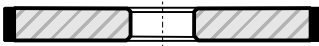

Techcentrum s.r.o., Moravská 40, 560 02 Česká Třebová
tel. 464 649 336, e-mail: brusivo@techcentrum.cz
Po konzultaci lze vyrobit i jiné tvary a rozměry kotoučů.

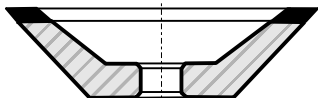
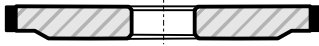
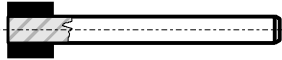
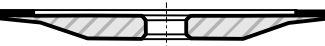
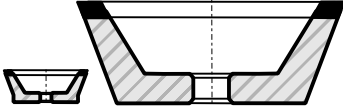
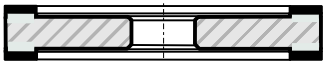
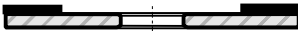
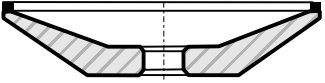
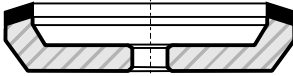
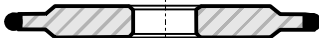
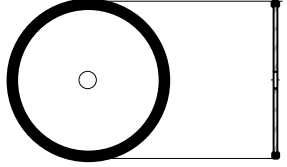
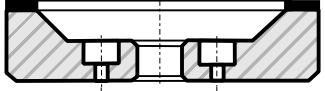
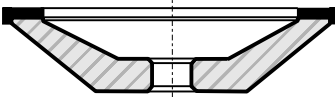
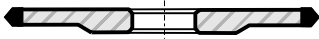
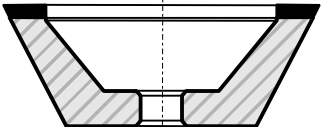
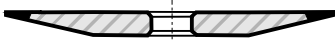
Přehled základních tvarů kotoučů na kovy.
 V případě požadavku jiného tvaru kontaktujte výrobce.

FEPA 6A2 	FEPA 11V9 	FEPA 4F1 	FEPA 3B1 
FEPA 11A2 	FEPA 12V9 	FEPA 4BT9 	FEPA 1L1 
FEPA 12A2/45° 	FEPA 12R4 	FEPA 4C9 	FEPA 14U1 
FEPA 12A2/20° 	FEPA 6A9 	FEPA 1A1 	FEPA 1A1, 1A8 
FEPA 4A2 	FEPA 12V2 	FEPA 3A1 	FEPA 1A1W 
FEPA 4A2S 	FEPA 11V2 	FEPA 9A3 	FEPA 1A2 
FEPA 12A2 	FEPA 11V5 	FEPA 14F1 	FEPA 1A1R 
FEPA 6A2B 	FEPA 12C9 	FEPA 3E1 	
FEPA 11B2 	FEPA 4ET9 	FEPA 3V1 	

Kvalita diamantových a CBN kotoučů

Brousící kotouče a tělíska s diamantem a kubickým nitridem boru (CBN) jsou určeny pro strojírenství a vyrábějí se pouze na zakázku do 2-3 týdnů. Nabízíme výrobu prachových diamantových a CBN nástrojů na opracování kovů, skla, drahých kamenů a keramiky. Ceníky obsahují pouze sériově vyráběné nástroje, jiný tvar nebo nástroj vyrobíme na požádání dle konkrétní poptávky ve firmě Techcetrum s.r.o. nebo na brusivo@techcentrum.cz.

Charakteristické znaky brousícího kotouče a tělíska:

1. Druh brusiva	4. Druh pojiva
2. Zrnitost brusiva	5. Rozměr kotouče nebo tělíska
3. Koncentrace brusiva	6. Tvar kotouče nebo tělíska

1. Druh brusiva

Brusivo	DIAMANT	DIAMANT	KUBICKÝ NITRID BORU
Broušený materiál	slinutý karbid slinutý karbid + ocel + pájka návarý obsahující WC, TiC	sklo,porcelán, keramika drahokamy,polodrahokamy, kámen žárovzdorné a vyzdívkové materiály tuha, grafit umělé hmoty s abrazivními plnivý	rychlořezné oceli (HSS) kalené oceli (nad 52 HRC) cementované oceli vysoce legované oceli (chromové apod.) litiny, wolfram tvrdé ocelové návarý

2. Zrnitost brusiva

FEPA	Zrnitost v mikronech		ISO R 565	ASTM - E - 11- 70		Použití	Orientační drsnost Ra
	diamantu	CBN		diamantu	CBN		
D/B 301	315/250	315/250	300/250	50/60	50/60	Účinné broušení a hrubování s vysokým výkonem	1,2 - 0,8
D/B 251	250/200	250/200	250/212	60/70	60/70		
D/B 213	200/160	200/160	212/180	70/80	70/80		
D/B 181			180/150	80/100	80/100		
D/B 151	160/125	160/125	150/125	100/120	100/120		
D/B 126	125/100	125/100	125/106	120/140	120/140		
D/B 107	100/80	100/80	106/90	140/170	140/170	Ostření řezných nástrojů	0,4
D/B 91			90/75	170/200	170/200		
D/B 76	80/63	80/63	75/63	200/230	200/230		
D/B 64	63/50	63/50	63/53	230/270	230/270		
D/B 54	50/40	50/40	53/45	270/325	270/325	Dokončovací broušení	0,2
D/B 46	40/36	40/36	45/38	325/400	325/400	Lapování	0,1
	40/28	40/28					
	36/25	36/25					
	28/20	28/20				Leštění	0,08
	20/14	28/20					
	14/10						
	10/7					Leštění	0,05
	7/5						

3. Koncentrace brusiva

Koncentrace brusiva vyjadřuje váhový obsah diamantu nebo CBN v 1cm³ brousící vrstvy, dle vzorce $K = g \cdot cm^3$ nebo $K = crt \cdot cm^3$.

Označení koncentrace: K

Volba koncentrace má značný vliv na efektivnost broušení.

Koncentrace (K)	25	40	50	75	100	125	150	175
	nízká			střední		vysoká		
Použití	leštění, zvláštní operace			běžné broušení		broušení otvorů, profilové broušení		
Vliv na broušení	dobré samoostřicí vlastnosti			většina brousících operací		horší samoostřicí vlastnosti		
	zvyšuje výkon broušení					snižuje výkon broušení		
	snižuje teplo					zvyšuje teplo		
	snižuje životnost kotouče					zvyšuje životnost kotouče		
	zhoršuje stálost tvaru					zlepšuje stálost tvaru		
	zvyšuje drsnost povrchu					snižuje drsnost povrchu		

4. Druh pojiva

Pojivo ovlivňuje životnost, výkon, tvarovou stálost a samoostřicí vlastnosti diamantových a CBN kotoučů a tělísek.

Pryskyřičné pojivo je nejpoužívanější při broušení slinutých karbidů a ocelí. Vyznačuje se vysokou produktivitou broušení, dobrými samoostřicími vlastnostmi a nízkým vývinem tepla. Toto pojivo je plněno pokoveným diamantem a CBN - není nutno chladit. Při chlazení prodloužujete životnost. Při použití do automatů se doporučuje nepokovený diamant (nutno uvést v objednávce).

Kovové pojivo označení při objednávce Bz se používá převážně s diamantem a vyznačuje se větší tvrdostí než pryskyřičné pojivo a je možno řídit jeho tvrdost. Toto pojivo je plněno nepokoveným diamantem - je nutno chladit vodovou emulzí.

Keramické pojivo označení při objednávce Ke je zatím nejučinnější pojivo. Vyznačuje se dlouhou životností, vysokou abrazností, vysokou přesností broušení a minimální potřebou oživovat nástroj. Toto pojivo je plněno nepokoveným diamantem a CBN - není nutno chladit.

5. Rozměr kotouče nebo tělíška

Volba rozměru brousícího kotouče nebo tělíška je dána typem stroje a druhem prováděné operace. Čím větší průměr brousícího kotouče, tím méně je následkem delší ochlazovací dráhy brusné zrna namáháno, což příznivě působí na životnost kotouče.

6. Tvar kotouče nebo tělíška

Brousící kotouče a tělíška jsou označovány typovým označením FEPA.

Příklad objednávání:

DIA kotouč 6A2 200x20/3x76 K100 D107 2ks

Slevy poskytujeme na další prodej, na množstevní odběr a hotovostní platbu.

Uvedené ceny jsou v Kč bez DPH.

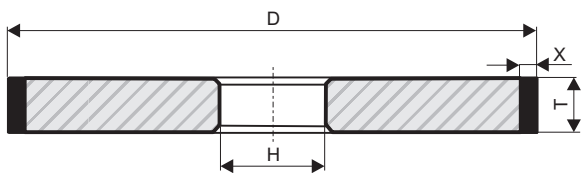

FEPA 1A1

D	T	PRYSKYŘIČNÉ		KERAMIKA		KERAMIKA		KOVOVÉ		H
		DIA	CBN	DIAMANT		CBN		DIAMANT		
		X		X		X		X		
		3	3	5	5	5	5	3	10	
50	3	556,-	688,-	990,-	1375,-	556,-				10
	4	583,-	740,-	1100,-	1485,-	583,-				10
	5	605,-	792,-	1210,-	1540,-	605,-				10
	8	693,-	935,-	1320,-	1870,-	693,-				10
	10	754,-	1056,-	1430,-	2090,-	754,-				10
	12	814,-	1276,-	1694,-	2530,-	814,-				10
60	20	1161,-	1309,-	1980,-	3190,-	1161,-				10
	8	814,-	1084,-	1540,-	2200,-	814,-				13
	10	836,-	1205,-	1650,-	2420,-	836,-				13
	12	930,-	1419,-	1870,-	2860,-	897,-				13
75	16	1078,-	1716,-	2200,-	3520,-	1078,-				13
	10	1089,-	1804,-	1870,-	3300,-	1089,-				13
	20	1661,-	2536,-	2860,-	4950,-	1661,-				13
80	3	902,-	1111,-	1760,-	2200,-		1320,-			13
	4	946,-	1298,-	1815,-	2530,-		1430,-			13
	6	1018,-	1469,-	1870,-	2860,-		1650,-			13
	8	1089,-	1859,-	1925,-	3190,-		1760,-			13
	10	1177,-	2079,-	2090,-	3520,-		1925,-			13
100	3	1452,-	1771,-	1980,-	2640,-		1595,-			20
	4	1513,-	1914,-	2090,-	2860,-		1738,-			20
	5	1584,-	2101,-	2200,-	3080,-		1892,-			20
	6	1645,-	2244,-	2310,-	3300,-		2035,-			20
	8	1755,-	2482,-	2750,-	3850,-		2310,-			20
	10	2085,-	2723,-	3300,-	4400,-		2706,-			20
125	20	2761,-	3949,-	4400,-	6600,-		4290,-			20
	3	1595,-	1942,-	2310,-	2970,-		2123,-			20
	4	1672,-	2101,-	2530,-	3190,-		2178,-			20
	5	1755,-	2261,-	2750,-	3410,-		2211,-			20
	6	1837,-	2431,-	2970,-	3850,-		2464,-			20
	10	2140,-	3157,-	3630,-	5060,-		3355,-			20
150	12	2310,-	3471,-	3960,-	5500,-		3729,-			20
	15	2580,-	3938,-	4400,-	5940,-		4719,-			20

D	T	PRYSKYŘIČNÉ		PRYSKYŘIČNÉ		KERAMIKA		KERAMIKA		KOVOVÉ		H
		DIAMANT		CBN		DIAMANT		CBN		DIAMANT		
		X		X		X		X		X		
		3	4	3	4	5	5	5	5	10		
150	3	1744,-	2090,-	2151,-	2890,-	2860,-	3410,-	3410,-	3410,-	2189,-	20	
	4	1843,-	2200,-	2338,-	3080,-	3190,-	3685,-	3685,-	3685,-	2200,-	20	
	5	1936,-	2365,-	2536,-	3300,-	3410,-	4070,-	4070,-	4070,-	2717,-	20	
	6	2035,-	2530,-	2750,-	3520,-	3630,-	4400,-	4400,-	4400,-	3256,-	20	
	8	2228,-	2970,-	3157,-	3960,-	3850,-	5280,-	5280,-	5280,-	3795,-	20	
	10	2541,-	3190,-	3592,-	4400,-	4070,-	5830,-	5830,-	5830,-	4389,-	20	
	12	3013,-	3575,-	4279,-	4895,-	4400,-	6490,-	6490,-	6490,-	4906,-	20	
	15	3724,-	4345,-	5099,-	5808,-	4840,-	7150,-	7150,-	7150,-	5555,-	20	
	20	4103,-	5720,-	6072,-	7480,-	5610,-	8800,-	8800,-	8800,-	7007,-	20	
175	30	5165,-	6930,-	7920,-	10670,-	7370,-	12650,-	12650,-	12650,-	9339,-	20	
	6	2200,-	2750,-	3102,-	4400,-	3850,-	5170,-	5170,-	5170,-	3630,-	32	
	10	3196,-	3630,-	4961,-	5500,-	4290,-	6490,-	6490,-	6490,-	4730,-	32	
	12	3608,-	4180,-	5489,-	6160,-	4620,-	7260,-	7260,-	7260,-	5577,-	32	
	15	3982,-	4708,-	5852,-	6490,-	5170,-	8415,-	8415,-	8415,-	6589,-	32	
	20	4455,-	6050,-	6589,-	8800,-	6160,-	10450,-	10450,-	10450,-	8228,-	32	
200	30	5555,-	7590,-	8949,-	12650,-	8030,-	13750,-	13750,-	13750,-	11660,-	32	
	8	3388,-	3520,-	4571,-	5500,-	4400,-	6270,-	6270,-	6270,-	4840,-	32-76	
	10	3608,-	4180,-	5016,-	6050,-	4840,-	7260,-	7260,-	7260,-	5390,-	32-76	
	12	3861,-	4620,-	5544,-	6930,-	5280,-	8360,-	8360,-	8360,-	6578,-	32-76	
	15	4307,-	5390,-	6325,-	8030,-	5830,-	9680,-	9680,-	9680,-	7667,-	32-76	
	20	4818,-	6600,-	7486,-	10120,-	6820,-	11990,-	11990,-	11990,-	9130,-	32-76	
250	30	6160,-	8140,-	9900,-	12100,-	9460,-	17050,-	17050,-	17050,-	12089,-	32-76	
	40	7590,-	9680,-	12314,-	14040,-		22110,-				32-76	
	10	4780,-	5390,-	6864,-	7920,-	6380,-	8690,-	8690,-	8690,-		32-76	
	12	5808,-	6160,-	8976,-	9900,-	7370,-	10340,-	10340,-	10340,-		32-76	
	15	6292,-	7260,-	10164,-	11990,-	8800,-	12650,-	12650,-	12650,-		32-76	
	20	7249,-	9075,-	11748,-	14850,-	11220,-	16720,-	16720,-	16720,-		32-76	
300	25	9880,-	10890,-	13332,-	18150,-	13530,-	20240,-	20240,-	20240,-		32-76	
	30	10527,-	12100,-	14916,-	19800,-	15840,-	23100,-	23100,-	23100,-		32-76	
	40	13189,-	15400,-	20064,-	25300,-	19800,-	31900,-	31900,-	31900,-		32-76	
	10	7370,-	7370,-	13200,-	13200,-	8360,-	15950,-	15950,-	15950,-		32-127	
20		12089,-	20900,-	20900,-	14850,-	23100,-	23100,-	23100,-		32-127		

D	T	PRYSKYŘIČNÉ		PRYSKYŘIČNÉ		KERAMIKA		KERAMIKA		KOVOVÉ		H
		DIAMANT		CBN		DIAMANT		CBN		DIAMANT		
		X		X		X		X		X		
		4	5	4	5	5	5	5	5	10		
300	30	15950,-		21400,-		20460,-		28600,-				32-127
	10	9000,-	9800,-	16000,-	17000,-							32-127
	20	13500,-	14700,-	22500,-	23000,-							32-127
350	30	16500,-	18000,-	25000,-	27500,-							32-127
	10	11500,-	13000,-	18000,-	20000,-							32-127
	20	16000,-	18000,-	24800,-	26000,-							32-127
400	30	19000,-	23000,-	27000,-	30000,-							32-127
	10				27000,-							32-127
	20		27000,-		38000,-							32-127
500	30		34500,-		45000,-							32-127

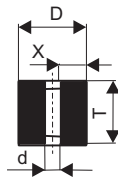
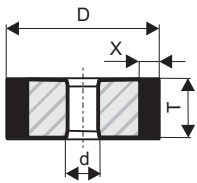

FEPA 1A1M, 1A8

D	T	PRYSKYŘIČNÉ DIAMANT				PRYSKYŘIČNÉ CBN				KERAMIKA DIAMANT				KERAMIKA CBN				H
		X				X				X				X				
		2	3	2	3	2	3	2	3	2	3	2	3	2	3	2	3	
5	5	171,-				209,-				209,-				253,-				3
	6	176,-				220,-				215,-				291,-				3
	8	182,-				231,-				220,-				281,-				3
	10	187,-				242,-				226,-				292,-				3
6	5	176,-				220,-				215,-				291,-				3
	6	182,-				231,-				220,-				281,-				3
	8	187,-				242,-				226,-				292,-				3
	10	193,-				253,-				256,-				308,-				3
7	5	182,-				231,-				220,-				281,-				4
	10	198,-				242,-				242,-				292,-				4
8	6	193,-				242,-				256,-				292,-				4
	8	198,-				253,-				242,-				308,-				4
	10	204,-				264,-				248,-				319,-				4
	12	209,-				275,-				253,-				363,-				4
10	8	209,-	231,-			286,-	385,-			253,-	281,-			347,-	509,-			4-6
	10	231,-	264,-			314,-	418,-			281,-	319,-			380,-	506,-			4-6
	12	264,-	319,-			341,-	435,-			319,-	385,-			413,-	523,-			4-6
	15	297,-	352,-			369,-	451,-			358,-	424,-			446,-	545,-			4-6
12	8	264,-	314,-			330,-	396,-			319,-	380,-			436,-	478,-			4-6
	10	286,-	336,-			358,-	424,-			347,-	407,-			473,-	512,-			4-6
	12	303,-	374,-			385,-	457,-			401,-	451,-			509,-	550,-			4-6
	15	325,-	435,-			407,-	517,-			391,-	523,-			490,-	622,-			4-6
14	10	418,-	517,-			440,-	523,-			506,-	622,-			581,-	691,-			4-6
	12	374,-	440,-			473,-	550,-			451,-	581,-			572,-	660,-			4-6
	15	396,-	468,-			501,-	583,-			479,-	619,-			605,-	704,-			4-6
	20	473,-	572,-			594,-	715,-			572,-	688,-			715,-	858,-			4-6
15	10	440,-	468,-			572,-	583,-			619,-	581,-			619,-	688,-			4-6
	15	468,-	484,-			583,-	605,-			619,-	583,-			704,-	775,-			4-6
	20	506,-	556,-			633,-	627,-			611,-	671,-			754,-	830,-			4-6
	25	572,-	611,-			688,-	759,-			688,-	737,-			825,-	913,-			4-6

Poznámka: 2 u D 6mm a D 7mm je X 1,5mm, u D 5mm je X 1mm

Techcentrum s.r.o. Česká Třebová tel. 464 649 336

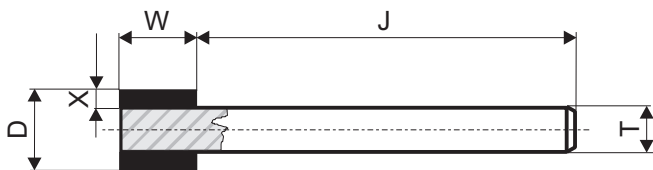

FEPA 1A1W

D	W	PRYSKYŘIČNÉ - DIAMANT				PRYSKYŘIČNÉ - CBN				KERAMIKA - DIAMANT				KERAMIKA - CBN				T	J
		X				X				X				X					
		0,5	1	1,5	2	0,5	1	1,5	2	0,5	1	1,5	2	0,5	1	1,5	2		
4	6	209,-				237,-												3	44
5	6		220,-				253,-											3	44
6	8		231,-				264,-											4	62
8	8			253,-				303,-										5	62
8	20			424,-				545,-										5	62
10	8				281,-							369,-						6	62
12	10				319,-							440,-						8	60

Techcentrum s.r.o. Česká Třebová tel. 464 649 336

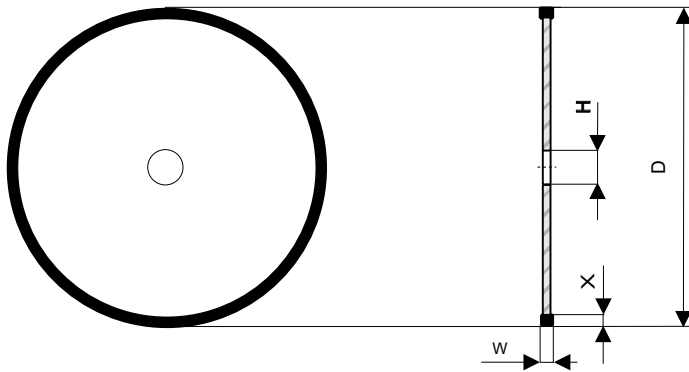

FEPA 1A1R

D	W	PRYSKYŹIĚNĚ - DIAMANT	PRYSKYŹIĚNĚ - CBN	H
		di lení tvrdokovu X 5	di lení ocelí a nerezů X 5	
125	1,5	1150,-	1495,-	20-32
150	1,7	1950,-	2535,-	20-32
200	1,8	2500,-	3250,-	20-76
250	1,8	3000,-	3900,-	20-76

Techcentrum s.r.o. Česká Třebová tel. 464 649 336

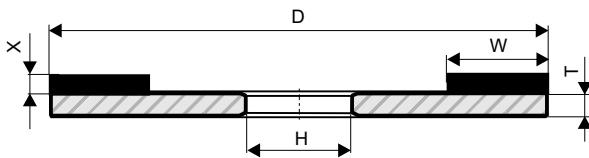

FEPA 1A2

D	W	PRYSKYŹIĚNĚ - DIAMANT			PRYSKYŹIĚNĚ - CBN			KOVOVÉ - DIAMANT			KOVOVÉ - CBN			T	H
		X			X			X			X				
		2	3	4	2	3	4	2	3	4	2	3	4		
125	10		2320,-			3157,-			2320,-			3157,-		6	20
	15		2450,-			3395,-			2450,-			3395,-		6	20
	20		2682,-			3662,-			2682,-			3662,-		6	20
	25		2930,-			3938,-			2930,-			3938,-		6	20
	27,5		3095,-			4000,-			3095,-			4000,-		6	70
	30		3202,-			4213,-			3202,-			4213,-		6	20
	40		3580,-			4610,-			3580,-			4610,-		6	20
	50		3999,-			5072,-			3999,-			5072,-		6	20

Techcentrum s.r.o. Česká Třebová tel. 464 649 336

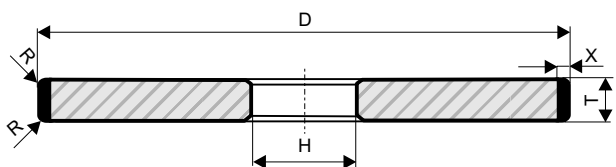

FEPA 1L1

D	T	PRYSKYŽIENÉ		KERAMIKA		KERAMIKA		KOVOVÉ		H
		DIA	CBN	DIAMANT		CBN		DIAMANT		
		X		X		X		X		
		3	3	5	5	5	5	3	10	
50	3	556,-	688,-	990,-		1375,-		556,-		10
	4	583,-	740,-	1100,-		1485,-		583,-		10
	5	605,-	792,-	1210,-		1540,-		605,-		10
	8	693,-	935,-	1320,-		1870,-		693,-		10
	10	754,-	1056,-	1430,-		2090,-		754,-		10
	12	814,-	1276,-	1694,-		2530,-		814,-		10
60	20	1161,-	1309,-	1980,-		3190,-		1161,-		10
	8	814,-	1084,-	1540,-		2200,-		814,-		13
	10	836,-	1205,-	1650,-		2420,-		836,-		13
	12	930,-	1419,-	1870,-		2860,-		897,-		13
75	16	1078,-	1716,-	2200,-		3520,-		1078,-		13
	10	1089,-	1804,-	1870,-		3300,-		1089,-		13
	20	1661,-	2536,-	2860,-		4950,-		1661,-		13
80	3	902,-	1111,-	1760,-		2200,-			1320,-	13
	4	946,-	1298,-	1815,-		2530,-			1430,-	13
	6	1018,-	1469,-	1870,-		2860,-			1650,-	13
	8	1089,-	1859,-	1925,-		3190,-			1760,-	13
	10	1177,-	2079,-	2090,-		3520,-			1925,-	13
100	3	1452,-	1771,-	1980,-		2640,-			1595,-	20
	4	1513,-	1914,-	2090,-		2860,-			1738,-	20
	5	1584,-	2101,-	2200,-		3080,-			1892,-	20
	6	1645,-	2244,-	2310,-		3300,-			2035,-	20
	8	1755,-	2482,-	2750,-		3850,-			2310,-	20
	10	2085,-	2723,-	3300,-		4400,-			2706,-	20
125	20	2761,-	3949,-	4400,-		6600,-			4290,-	20
	3	1595,-	1942,-	2310,-		2970,-			2123,-	20
	4	1672,-	2101,-	2530,-		3190,-			2178,-	20
	5	1755,-	2261,-	2750,-		3410,-			2211,-	20
	6	1837,-	2431,-	2970,-		3850,-			2464,-	20
	10	2140,-	3157,-	3630,-		5060,-			3355,-	20
	12	2310,-	3471,-	3960,-		5500,-			3729,-	20
15	2580,-	3938,-	4400,-		5940,-			4719,-	20	

D	T	PRYSKYŽIENÉ		PRYSKYŽIENÉ		KERAMIKA		KERAMIKA		KOVOVÉ		H
		DIAMANT		CBN		DIAMANT		CBN		DIAMANT		
		X		X		X		X		X		
		3	4	3	4	5	5	5	5	10		
150	3	1744,-	2090,-	2151,-	2860,-	2860,-		3410,-		2189,-	20	
	4	1843,-	2200,-	2338,-	3080,-	3190,-		3685,-		2200,-	20	
	5	1936,-	2365,-	2536,-	3300,-	3410,-		4070,-		2717,-	20	
	6	2035,-	2530,-	2750,-	3520,-	3630,-		4400,-		3256,-	20	
	8	2228,-	2970,-	3157,-	3960,-	3850,-		5280,-		3795,-	20	
	10	2541,-	3190,-	3592,-	4400,-	4070,-		5830,-		4389,-	20	
	12	3013,-	3575,-	4279,-	4895,-	4400,-		6490,-		4906,-	20	
	15	3724,-	4345,-	5099,-	5808,-	4840,-		7150,-		5555,-	20	
175	20	4103,-	5720,-	6072,-	7480,-	5610,-		8800,-		7007,-	20	
	6	2200,-	2750,-	3102,-	4400,-	3850,-		5170,-		3630,-	32	
	10	3196,-	3630,-	4961,-	5500,-	4290,-		6490,-		4730,-	32	
	12	3608,-	4180,-	5489,-	6160,-	4620,-		7260,-		5577,-	32	
	15	3982,-	4708,-	5852,-	6490,-	5170,-		8415,-		6589,-	32	
200	20	4455,-	6050,-	6589,-	8800,-	6160,-		10450,-		8228,-	32	
	8	3388,-	3520,-	4571,-	5500,-	4400,-		6270,-		4840,-	32-76	
	10	3608,-	4180,-	5016,-	6050,-	4840,-		7260,-		5390,-	32-76	
	12	3861,-	4620,-	5544,-	6930,-	5280,-		8360,-		6578,-	32-76	
	15	4307,-	5390,-	6325,-	8030,-	5830,-		9680,-		7667,-	32-76	
20	4818,-	6600,-	7486,-	10120,-	6820,-		11990,-		9130,-	32-76		

Techcentrum s.r.o. Česká Třebová tel. 464 649 336

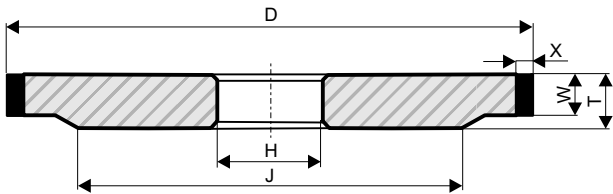

FEPA 3A1

D	W	PRYSKYŽIĚNÉ - DIAMANT				PRYSKYŽIĚNÉ - CBN				KERAMIKA DIA		KERAMIKA CBN		KOVOVÉ - DIAMANT				T	H	J
		X				X				X		X		X						
		2	3	4	5	2	3	4	5	5		5		1,5	2	3	4			
75	1,5			930,-				1100,-			1210,-		1650,-					4	20	30
	1,8			946,-				1133,-			1397,-		1815,-					4	20	55
	2			957,-				1161,-			1485,-		1980,-					4	20	55
	2,2			979,-				1265,-			1518,-		2145,-					4,5	20	55
	2,5			996,-				1320,-			1540,-		2310,-					4,5	20	55
	2,8			1018,-				1397,-			1595,-		2420,-					5	20	55
	3			1040,-				1441,-			1650,-		2530,-					5,5	20	55
	4			1078,-				1529,-			1870,-		2805,-					6	20	55
	5			1139,-				1650,-			1980,-		3080,-					7	20	55
	4	968,-						1375,-										6,5	13	50
6	1018,-						1414,-			2310,-		3300,-					8,5	13	50	
8	1067,-						1529,-			2420,-		3410,-					10,5	13	50	
100	4	1513,-					1914,-			2090,-		2970,-					6,5	20	70	
	6	1645,-					2244,-			2310,-		3300,-					8,5	20	70	
	8	1755,-					2482,-			2750,-		3850,-					10,5	20	70	
125	4	1672,-					2101,-			2530,-		3190,-					6,5	20	77	
	6	1837,-					2431,-			2970,-		3850,-					8,5	20	77	
	8	2057,-					2750,-			3300,-		4400,-					10,5	20	77	
150	6	2035,-					2750,-			3630,-		4400,-					8,5	20	95	
	8	2233,-					3157,-			3850,-		5280,-					10,5	20	95	
	8																10,5	20	95	
175	6						3102,-			3850,-		5170,-					8,5	32	120	
	8						3905,-			4070,-		5830,-					10,5	32	120	
200	8		3388,-					4565,-			4400,-		6270,-				10,5	32	145	

Techcentrum s.r.o. Česká Třebová tel. 464 649 336

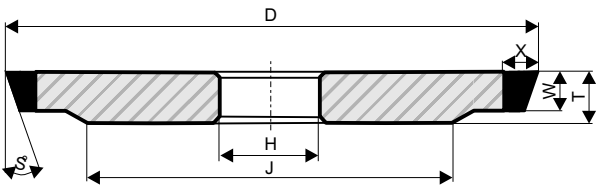

FEPA 3B1

D	W	PRYSKYŽIĚNÉ - DIAMANT		PRYSKYŽIĚNÉ - CBN		KERAMIKA DIA		KERAMIKA CBN		KOVOVÉ - DIAMANT		T	H	J
		X	S°	X	S°	X	S°	X	S°	X	S°			
		4		4		5		5		4				
75	1,5	858,-	10	1018,-	10	1210,-	10	1540,-	10	858,-	10	4	20	55
	1,5	858,-	15	1018,-	15	1210,-	15	1540,-	15	858,-	15	4	20	55
	2	935,-	10	1018,-	10	1320,-	10	1650,-	10	935,-	10	4	20	56
	3	990,-	10	1199,-	10	1540,-	10	1980,-	10	990,-	10	5,5	20	55
	4	1045,-	5	1320,-	5	1760,-	5	2310,-	5	1045,-	5	6	20	56
	4	1045,-	10	1320,-	10	1760,-	10	2310,-	10	1045,-	10	6	20	56
	5	1111,-	5	1584,-	5	1980,-	5	2530,-	5	1111,-	5	7	20	56
	5	1111,-	10	1584,-	10	1980,-	10	2530,-	10	1111,-	10	7	20	56

Techcentrum s.r.o. Česká Třebová tel. 464 649 336

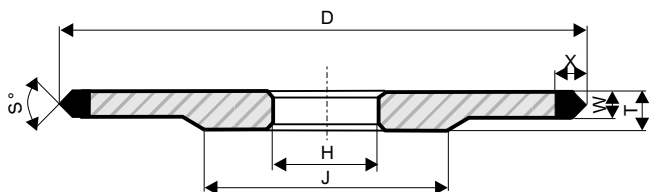

FEPA 3E1

D	W	PRYSKYŮŽENÉ - DIAMANT			PRYSKYŮŽENÉ - CBN			KERAMIKA - DIAMANT			KERAMIKA - CBN			KOVOVÉ - DIAMANT			T	H	J
		X/S°			X/S°			X/S°			X/S°			X/S°					
		7/30°	5/60°	5/90°	7/30°	5/60°	5/90°	10/30°	10/60°	10/90°	10/30°	10/60°	10/90°	7/30°	5/60°	5/90°			
75	3	1111,-	1089,-	1089,-	1485,-	1463,-	1463,-	1815,-	1760,-	1760,-	2145,-	2090,-	2090,-	1111,-	1089,-	1089,-	6,5	20	31
100	3	1755,-	1716,-	1716,-	2376,-	2338,-	2338,-	2090,-	2024,-	2024,-	2860,-	2750,-	2750,-	1755,-	1559,-	1559,-	6,5	20	56
125	3	1997,-	1973,-	1973,-	2812,-	2783,-	2783,-	2640,-	2530,-	2530,-	3410,-	3300,-	3300,-	1997,-	1973,-	1973,-	6,5	32	83
150	3	2167,-	2118,-	2118,-	3152,-	3102,-	3102,-	3300,-	2849,-	2849,-	3960,-	3850,-	3850,-	2167,-	2118,-	2118,-	6,5	32	108
150	5		2359,-														6,5	32	108

Techcentrum s.r.o. Česká Třebová tel. 464 649 336

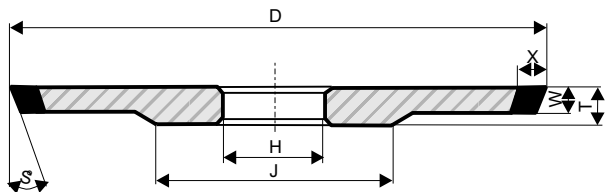

FEPA 3V1

D	W	PRYSKYŮŽENÉ - DIAMANT			PRYSKYŮŽENÉ - CBN			KERAMIKA - DIAMANT		KERAMIKA - CBN			T	H	J	
		X		S°	X		S°	X	S°	X		S°				
		4	6		4	6		5		5						
50	4		891,-	15		1188,-	15	1210,-		15	1485,-		15	5,5	10	21
	4		891,-	25		1188,-	25	1210,-		25	1485,-		25	5,5	10	21
75	2,5	919,-		15	1243,-		15	1540,-		15	1980,-		15	5	20	50
	2,5	919,-		20	1243,-		20	1540,-		20	1980,-		20	5	20	50
	3,5	990,-		15	1293,-		15	1760,-		15	2310,-		15	6	20	50
	3,5	990,-		20	1293,-		20	1760,-		20	2310,-		20	6	20	50
	4		1172,-	15		1624,-	15	1870,-		15	2420,-		15	5,5	13	21
	4		1172,-	25		1624,-	25	1870,-		25	2420,-		25	5,5	13	31
	5	1111,-		15	1573,-		15	1980,-		15	2530,-		15	7	20	51
	5	1111,-		25	1573,-		25	1980,-		25	2530,-		25	7	20	51
100	7	1293,-		15	1705,-		15	2310,-		15	2860,-		15	9	20	51
	5		1837,-	15		2536,-	15	2090,-		15	2640,-		15	6,5	20	44
125	5		1837,-	25		2536,-	25	2090,-		25	2640,-		25	6,5	20	44
	6		2299,-	15		3300,-	15	2420,-		15	3300,-		15	7,5	20	59
125	6		2299,-	25		3300,-	25	2420,-		25	3300,-		25	7,5	20	59

Techcentrum s.r.o. Česká Třebová tel. 464 649 336

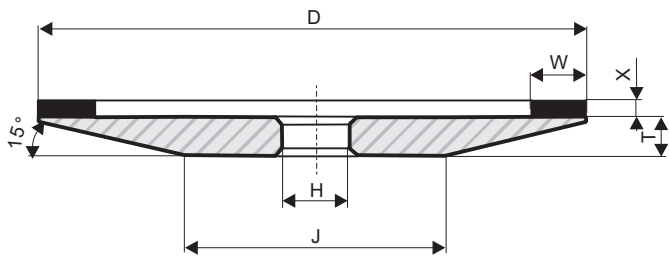

FEPA 4A2

D	W	PRYSKYŘIČNÉ - DIAMANT			PRYSKYŘIČNÉ - CBN			KERAMIKA DIA		KERAMIKA CBN		KOVOVÉ - DIAMANT			T	H	J
		X			X			X		X		X					
		2	3	4	2	3	4	3	3	3	3	1,5	2	3			
50	2	660,-	677,-	693,-	792,-	803,-	831,-	1265,-		1430,-			677,-	693,-	6	10	17
	3	688,-	704,-	715,-	820,-	831,-	858,-	1375,-		1540,-					6	10	17
	4	704,-	715,-	750,-	831,-	858,-	886,-	1540,-		1760,-					6	10	17
75	2	963,-	968,-	1005,-	1095,-	1150,-	1199,-	1870,-		1980,-			968,-	1007,-	6	13	41
	3	1012,-	1041,-	1089,-	1188,-	1227,-	1282,-	2090,-		2200,-					6	13	41
	4	1040,-	1122,-	1162,-	1254,-	1348,-	1463,-	2145,-		2310,-					6	13	41
	5	1089,-	1188,-	1243,-	1359,-	1507,-	1650,-	2200,-		2199,-					6	13	41
	10	1188,-	1271,-	1380,-	1518,-	1755,-	1991,-	2310,-		2640,-			1271,-	1381,-	6	13	41
100	2	1452,-	1491,-	1529,-	1716,-	1782,-	1914,-	2200,-		2420,-					6	20	66
	3	1584,-	1634,-	1694,-	1848,-	1942,-	2101,-	2310,-		2640,-					6	20	66
	4	1634,-	1672,-	1738,-	1980,-	2046,-	2233,-	2420,-		2860,-					6	20	66
	5	1694,-	1793,-	2118,-	2112,-	2244,-	2429,-	2530,-		3080,-					6	20	66
	10	1876,-	2057,-	2178,-	2445,-	2574,-	2695,-	2970,-		3630,-			2057,-	2178,-	6	20	66
125	2	1936,-	2024,-	2085,-	2261,-	2431,-	2552,-								7	20	84
	3	2057,-	2142,-	2200,-	2387,-	2563,-	2866,-	2420,-		2860,-					7	20	84
	4	2107,-	2189,-	2261,-	2482,-	2640,-	3009,-	2750,-		3300,-					7	20	84
	5	2189,-	2310,-	2431,-	2640,-	2937,-	3168,-	2970,-		3630,-					7	20	84
	10	2349,-	2503,-	2701,-	2899,-	3366,-	3867,-	3300,-		4400,-			2503,-	2701,-	7	20	84
	15	2503,-	2761,-	3075,-	3163,-	4527,-	4395,-	3740,-		5170,-			2761,-	3075,-	7	20	84
150	2	2068,-	2118,-	2178,-	2508,-	2618,-	2904,-								9	20	94
	3	2019,-	2277,-	2371,-	2761,-	2915,-	3196,-	2750,-		3740,-					9	20	94
	4	2316,-	2420,-	2569,-	2827,-	2959,-	3300,-	3025,-		4125,-					9	20	94
	5	2431,-	2580,-	2712,-	2849,-	3207,-	3537,-	3300,-		4510,-					9	20	94
	10	2613,-	2855,-	3097,-	3366,-	3856,-	4395,-	3740,-		4950,-			2855,-	3097,-	9	20	94
	15	3157,-	3388,-	3619,-	4158,-	4807,-	5401,-	4070,-		5500,-			3388,-	3619,-	9	20	94
	20	3751,-	4164,-	4746,-	5071,-	5957,-	7145,-	4620,-		6380,-					9	20	94
25	4235,-	4780,-	5313,-	5786,-	6947,-	8052,-	5170,-		7480,-					9	20	94	
175	2	2409,-	2541,-	2662,-	2668,-	2882,-	3168,-								10	32	111
	3	2541,-	2684,-	2794,-	2838,-	3075,-	3366,-	3080,-		4070,-					10	32	111
	5	2772,-	2816,-	3097,-	3124,-	3658,-	4279,-	3520,-		5060,-					10	32	111
	10	3135,-	3427,-	3812,-	4015,-	4202,-	5115,-	4070,-		6270,-			3427,-	3812,-	10	32	111
	15	3427,-	3850,-	4235,-	4620,-	4659,-	5412,-	4950,-		7260,-			3850,-	4235,-	10	32	111
200	20	3916,-	4274,-	4950,-	5346,-	6573,-	7673,-	5500,-		7700,-			4274,-	4950,-	10	32	111
	10	3600,-	3900,-	4200,-	4600,-	5300,-	5900,-						3900,-	4200,-	12	32	121
	15	4000,-	4400,-	4800,-	5200,-	6100,-	7000,-						4400,-	4800,-	12	32	121
250	20	4400,-	5000,-	5600,-	6200,-	7400,-	8600,-						5000,-	5600,-	12	32	121
	10	4400,-	4800,-	5200,-	5600,-	6400,-	8600,-						4800,-	5200,-	14	76	156
	15	4700,-	5400,-	6000,-	6400,-	7600,-	8800,-						5400,-	6000,-	14	76	156
	20	5100,-	5800,-	6500,-	7200,-	8800,-	10300,-						5800,-	6500,-	14	76	156

Techcentrum s.r.o. Česká Třebová tel. 464 649 336

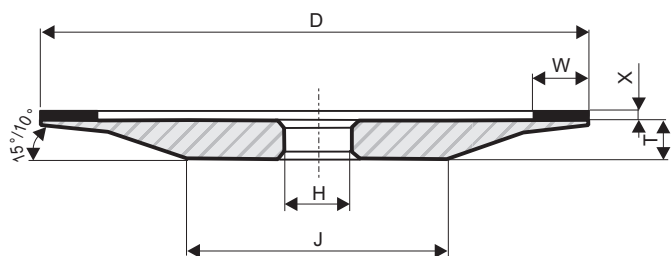

FEPA 4A2S

D	W	PRYSKYŘIČNÉ - DIAMANT		PRYSKYŘIČNÉ - CBN		KOVOVÉ - DIAMANT		T	H	J
		X		X		X				
		2	2	2	2	2	2			
100	4	1634,-	1980,-	1672,-				6	20	66
	5	1694,-	2112,-	1793,-				6	20	66
	10	1876,-	2445,-	2057,-				6	20	66
125	4	2107,-	2482,-	2189,-				7	20	84
	5	2189,-	2640,-	2310,-				7	20	84
	10	2349,-	2899,-	2503,-				7	20	84
150	4	2316,-	2827,-	2420,-				9	20	94
	5	2431,-	2849,-	2580,-				9	20	94
	10	2613,-	3366,-	2855,-				9	20	94
175	4	2541,-	2838,-	2720,-				10	32	111
	5	2772,-	3124,-	2816,-				10	32	111
	10	3135,-	4015,-	3427,-				10	32	111

Techcentrum s.r.o. Česká Třebová tel. 464 649 336

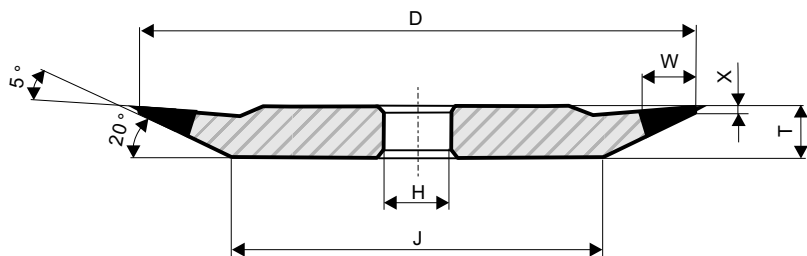

FEPA 4BT9

D	W	PRYSKYØIÈNÉ - DIAMANT			PRYSKYØIÈNÉ - CBN			T	H	J
		X			X					
		1			1					
75	6	1540,-			1980,-			8	20	37
100	10	1980,-			2585,-			10	20	50
125	10	2310,-			3355,-			12	20	65

Techcentrum s.r.o. Česká Třebová tel. 464 649 336

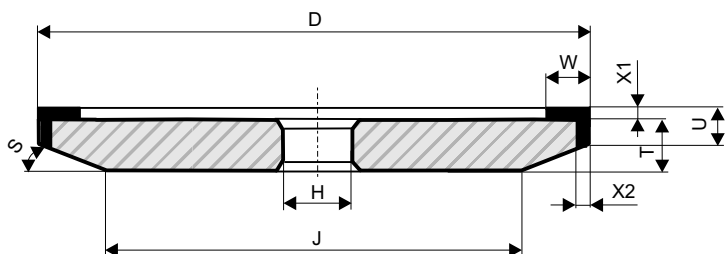

FEPA 4C9

D	W	U	PRYSKYØIÈNÉ - DIAMANT		PRYSKYØIÈNÉ - CBN		KOVOVÉ - DIAMANT		T	H	J	S
			X1	X2	X1	X2	X1	X2				
			2	2	2	2	2	2				
75	10	10		1890,-		2740,-		1890,-	15	13	46	20
100	10	10		2650,-		3842,-		2650,-	15	20	60	15
125	10	10		3200,-		4640,-		3200,-	15	20	65	10
150	10	10		3600,-		5220,-		3600,-	18	20	56	10
	15	10		3760,-		5452,-		3760,-	18	20	56	10
200	10	10		3800,-		5510,-		3800,-	18	32	106	10

Techcentrum s.r.o. Česká Třebová tel. 464 649 336

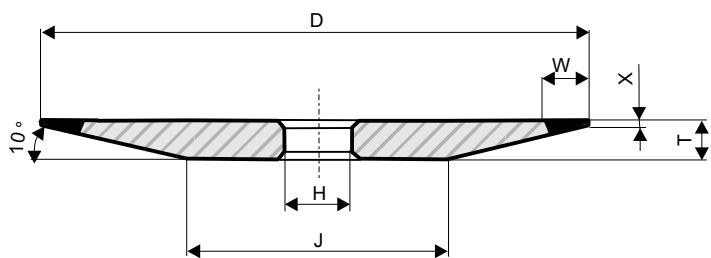

FEPA 4ET9

D	W	PRYSKYØIÈNÉ - DIAMANT			PRYSKYØIÈNÉ - CBN			T	H	J
		X			X					
		1	2		1	2				
75	4	1540,-			1980,-			6	20	35
100	4	1980,-			2585,-			6	20	43
125	5		2475,-			2915,-		8	20	57
150	5		2618,-			3190,-		10	20	59

Techcentrum s.r.o. Česká Třebová tel. 464 649 336

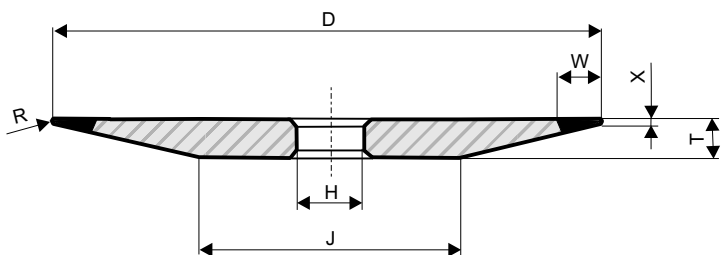

FEPA 4F1

D	W	PRYSKYØIÈNÉ - DIAMANT			PRYSKYØIÈNÉ - CBN			T	H	J
		X			X					
		1	2		1	2				
75	4	1540,-			1980,-			6	20	35
100	4	1980,-			2585,-			6	20	43
125	5		2475,-			2915,-		8	20	57
150	5		2618,-			3190,-		10	20	59

Techcentrum s.r.o. Česká Třebová tel. 464 649 336

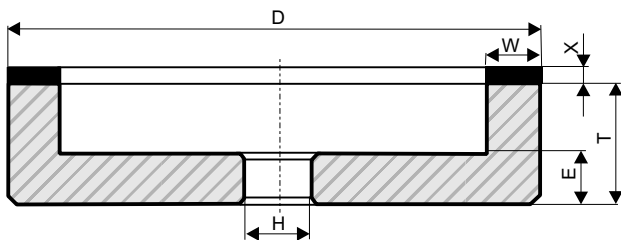

FEPA 6A2

D	W	PRYSKYČIĚNÉ - DIAMANT				PRYSKYČIĚNÉ - CBN				KERAMIKA DIA		KERAMIKA CBN		KOVOVÉ DIAMANT			T	E	H
		X				X				X		X		X					
		2	3	4	5	2	3	4	5	3	5	3	5	2	3	4			
50	2	715,-	726,-			825,-	858,-							726,-	693,-	704,-	20	10	10
	3	737,-	748,-			869,-	913,-							748,-	770,-	792,-	20	10	10
	4	759,-	770,-	803,-		902,-	946,-	1067,-						770,-	792,-	814,-	20	10	10
75	3	1078,-	1100,-			1265,-	1342,-			2090,-	2420,-	2200,-	2530,-				20	10	13
	4	1100,-	1122,-	1155,-		1320,-	1419,-	1529,-		2145,-	2475,-	2310,-	2640,-	1122,-	1155,-	1199,-	20	10	13
	5	1155,-	1232,-	1265,-	1320,-	1426,-	1573,-	1716,-	1859,-	2200,-	2530,-	2420,-	2750,-	1232,-	1265,-	1320,-	20	10	13
	10	1287,-	1375,-	1441,-	1551,-	1584,-	1826,-	2057,-	2299,-	2310,-	2750,-	2640,-	3300,-	1353,-	1441,-	1551,-	20	10	13
100	4	1694,-	1749,-	1826,-		1980,-	2134,-	2299,-		2420,-	2530,-	2860,-	3300,-	1749,-	1826,-	1892,-	23	10	20
	5	1749,-	1848,-	2178,-	2299,-	2178,-	2310,-	2497,-	2772,-	2530,-	2695,-	3080,-	3630,-	1848,-	2178,-	2301,-	23	10	20
	10	1936,-	2112,-	2233,-	2387,-	2508,-	2640,-	2772,-	3300,-	2970,-	3300,-	3630,-	4400,-	2112,-	2233,-	2387,-	23	10	20
125	4	2178,-	2255,-	2332,-	2420,-	2563,-	2728,-	2959,-	3102,-	2750,-	3080,-	3300,-	3960,-	2255,-	2332,-	2420,-	23	10	20
	5	2255,-	2387,-	2508,-	2629,-	2728,-	2992,-	3256,-	3564,-	2970,-	3300,-	3630,-	4400,-	2387,-	2508,-	2519,-	23	10	20
	10	2420,-	2574,-	2783,-	2992,-	3036,-	3487,-	3960,-	4356,-	3300,-	3850,-	4400,-	5390,-	2574,-	2783,-	2992,-	23	10	20
	15	2574,-	2838,-	3146,-	3079,-	3432,-	4092,-	4620,-	5280,-	3740,-	4510,-	5170,-	6820,-	2838,-	3146,-	3388,-	23	10	20
150	5	2541,-	2684,-	2816,-	2970,-	3091,-	3377,-	3696,-	4092,-	3300,-	3850,-	4510,-	5500,-	2684,-	2816,-	2970,-	23	10	20
	10	2717,-	2959,-	3201,-	3443,-	3498,-	3982,-	4532,-	5060,-	3740,-	4290,-	4950,-	6820,-	2959,-	3201,-	3443,-	23	10	20
	15	3267,-	3498,-	3729,-	4081,-	4312,-	4939,-	5544,-	6325,-	4070,-	4840,-	5500,-	8580,-	3498,-	3641,-	4081,-	23	10	20
	20	3872,-	4290,-	4851,-	5313,-	5192,-	6072,-	7260,-	8184,-	4840,-	5720,-	6600,-	9570,-	4290,-	4851,-	4213,-	23	10	20
	25	4356,-	4884,-	5423,-	5962,-	5896,-	7062,-	8503,-	9493,-	5610,-	6600,-	8690,-	10890,-	4884,-	5423,-	5962,-	23	10	20
175	5	2904,-	2959,-	3245,-	3432,-	3553,-	3806,-	4422,-	4675,-	3520,-	4070,-	5060,-	6050,-	2959,-	3245,-	3410,-	23	13	32
	10	3267,-	3564,-	3971,-	4246,-	4169,-	4818,-	5544,-	6149,-	4070,-	4840,-	6270,-	7040,-	3564,-	3971,-	4246,-	23	13	32
	15	3564,-	3993,-	4378,-	4785,-	4774,-	5676,-	6589,-	7458,-	4950,-	6160,-	7260,-	9570,-	3993,-	4378,-	4785,-	23	13	32
	20	3993,-	4532,-	5082,-	5687,-	5500,-	6732,-	7832,-	9042,-	5610,-	6490,-	7810,-	10340,-	4532,-	5082,-	5687,-	23	13	32
200	25	4235,-	4840,-	5500,-	6171,-	6138,-	7392,-	8778,-	10164,-	6270,-	6820,-	8690,-	11770,-	4840,-	5500,-	6171,-	23	13	32
	10	4114,-	4477,-	4774,-	5115,-	5192,-	5940,-	6600,-	7381,-	5060,-	5390,-	6820,-	7810,-	4477,-	4774,-	5115,-	23	13	32
	15	4477,-	4950,-	5423,-	5533,-	5896,-	6930,-	7964,-	8448,-	6050,-	6160,-	8140,-	10230,-	4950,-	5423,-	5533,-	23	13	32
	20	5060,-	5742,-	6413,-	7073,-	6930,-	8250,-	9647,-	10802,-	6600,-	7370,-	9130,-	12100,-	5742,-	6413,-	7073,-	23	13	32
250	25	5445,-	6204,-	7007,-	7744,-	7568,-	9185,-	10857,-	12540,-	7150,-	8250,-	10010,-	13860,-	6237,-	7007,-	7744,-	23	13	32
	8	4840,-	5203,-	5566,-	5918,-	6006,-	6941,-	7524,-	8250,-	6160,-	6600,-	7700,-	9570,-	5203,-	5566,-	5918,-	25	13	76
	10	4961,-	5379,-	5874,-	6292,-	6314,-	7150,-	8184,-	9064,-	6380,-	7040,-	8140,-	10230,-	5379,-	5874,-	6292,-	25	13	76
	15	5379,-	6050,-	6644,-	7249,-	7194,-	8580,-	9834,-	11187,-	6930,-	8030,-	10010,-	12320,-	6050,-	6644,-	7249,-	25	13	76
250	20	5808,-	6589,-	7381,-	8173,-	8052,-	9834,-	11484,-	13178,-	7920,-	9020,-	13420,-	16170,-	6589,-	7381,-	8173,-	25	13	76

Techcentrum s.r.o. Česká Třebová tel. 464 649 336

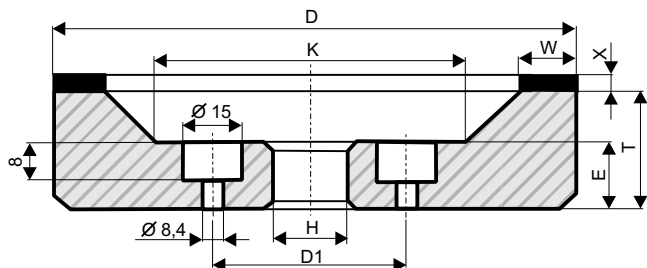

FEPA 6A2B

D	W	KERAMIKA - DIAMANT		PRYSKYČIĚNÉ, KOVOVÉ-DIAMANT		T	E	H	K	D1
		X		X						
		3	5	3	5					
100	10	2970,-	3300,-			23	13	20	80	40
	15	3740,-	4290,-			25	13	50	88	70
150	10	4070,-	4840,-			25	13	50	91	70
	15	4400,-	5390,-			25	13	50	86	70
	20	4840,-	6050,-			22	12	50	92	50
	25	4840,-	6050,-			22	12	50	92	50
175	10	4070,-	4840,-			25	13	50	104	70
	15	4950,-	6160,-			25	13	50	94	70
	20	5500,-	6820,-			25	13	50	94	70
	25	5940,-	7480,-			25	13	50	91	70
200	10	5060,-	5390,-			25	13	50	128	70
	15	6050,-	6160,-			25	13	50	118	70
	20	6600,-	7370,-			25	13	50	108	70
	25	7150,-	8140,-			25	13	50	98	70
250	10	6160,-	7040,-			30	18	76	178	100
	15	6930,-	8030,-			30	18	76	168	100
	20	7920,-	9020,-			30	18	76	158	100

Techcentrum s.r.o. Česká Třebová tel. 464 649 336

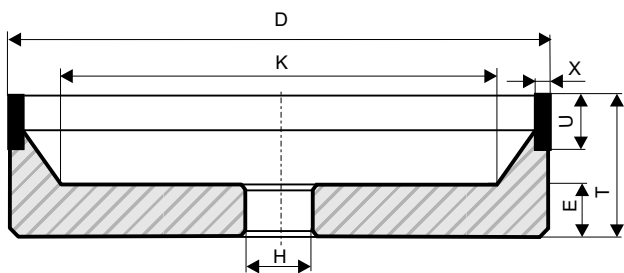

FEPA 6A9

D	U	PRYSKY I NĚ - DIAMANT			PRYSKY I NĚ - CBN			KERAMIKA - DIAMANT			KERAMIKA - CBN			T	E	H	K
		X			X			X			X						
		2	3	4	2	3	4	2	3	4	2	3	4				
75	6	1155,-	1298,-		1309,-	1573,-								25	10	13	60
	10	1232,-	1375,-		1584,-	1815,-								25	10	20	60
100	6	1749,-	1848,-		2178,-	2310,-								30	10	20	80
	10	1935,-	2110,-		2508,-	2640,-								30	10	20	80
125	6	2255,-	2387,-		2728,-	2992,-								30	10	20	107
	10	2420,-	2574,-		3036,-	3454,-								30	10	20	107
150	6	2541,-	2684,-		3080,-	3377,-								35	10	20	132
	10	2717,-	2959,-		3498,-	3982,-								35	10	20	132

Techcentrum s.r.o. Česká Třebová tel. 464 649 336

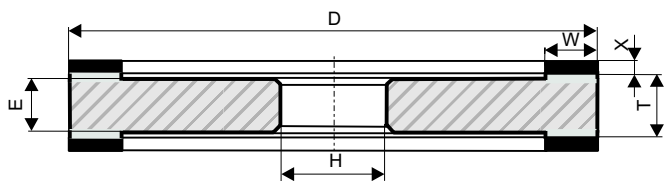

FEPA 9A3

D	W	PRYSKYØIĚNĚ - DIAMANT			PRYSKYØIĚNĚ - CBN			KERAMIKA DIA		KERAMIKA CBN		T	E	H
		X			X			X		X				
		2	3	4	2	3	4	3	5	3	5			
100	10	2541,-	2662,-	2959,-	3168,-	3426,-	4092,-	3300,-	4290,-	4400,-	5500,-	12	11	20
125	5	2662,-	2833,-	3047,-	3355,-	3525,-	3815,-	3740,-	4950,-	4070,-	7150,-	14	12	20
	10	2844,-	3168,-	3570,-	4125,-	5005,-	5676,-	4180,-	5720,-	6050,-	9680,-	12	11	20
150	5	2844,-	3388,-	3592,-	3762,-	4329,-	5016,-	4180,-	5610,-	4510,-	7700,-	12	11	20
	10	3267,-	3861,-	4235,-	4554,-	5929,-	6732,-	4840,-	7040,-	6600,-	9900,-	12	11	20
	15	4054,-	4538,-	5192,-	6006,-	7260,-	7524,-	5500,-	8250,-	8250,-	13200,-	12	11	20
175	5	3267,-	3993,-	3982,-	4356,-	5016,-	5874,-	4950,-	6270,-	5500,-	8250,-	12	11	20
	10	3955,-	4582,-	4143,-	5434,-	6534,-	8173,-	5940,-	6930,-	7480,-	11000,-	16	15	20
	20	5203,-	6358,-	7469,-	7893,-	10164,-	12595,-	7810,-	9790,-	13200,-	18150,-	16	15	20
200	5	4235,-	4587,-	4983,-	5308,-	6061,-	6864,-	5500,-	6820,-	6600,-	9350,-	12	11	20
	10	5071,-	5676,-	6353,-	6837,-	8369,-	9757,-	6600,-	7700,-	9130,-	12100,-	18	17	20
	20	6738,-	7926,-	9356,-	9570,-	12540,-	15829,-	8800,-	10230,-	15400,-	22000,-	18	17	20

Techcentrum s.r.o. Česká Třebová tel. 464 649 336

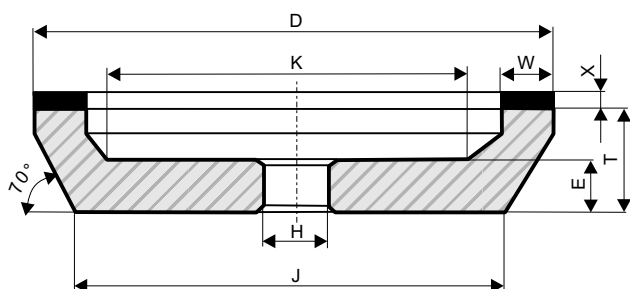

FEPA 11A2

D	W	PRYSKYŔIENÉ - DIAMANT			PRYSKYŔIENÉ - CBN			KERAMIKA DIA		KERAMIKA CBN		KOVOVÉ - DIA		T	E	H	J	K
		X			X			X		X		X						
		2	3	4	2	3	4	3	5	3	5	2	3					
75	3	1078,-	1100,-	1122,-	1265,-	1342,-	1430,-	2090,-	2420,-	2200,-	2530,-			20	10	13	63	64
	4	1100,-	1122,-	1155,-	1320,-	1419,-	1529,-	2145,-	2475,-	2310,-	2640,-			20	10	13	63	62
	5	1155,-	1232,-	1265,-	1419,-	1573,-	1716,-	2200,-	2530,-	2420,-	2750,-	1232,-	1265,-	20	10	13	63	58
	10	1287,-	1375,-	1441,-	1584,-	1826,-	2057,-	2310,-	2750,-	2640,-	3300,-	1375,-	1441,-	20	10	13	63	50
100	3	1639,-	1705,-	1771,-	1870,-	1980,-	2112,-	2310,-	2420,-	2640,-	3080,-			20	10	20	88	89
	4	1694,-	1749,-	1826,-	1980,-	2134,-	2299,-	2420,-	2530,-	2860,-	3300,-			20	10	20	88	87
	5	1749,-	1848,-	2178,-	2178,-	2310,-	2497,-	2530,-	2695,-	3080,-	3630,-	1848,-	2178,-	20	10	20	88	83
	10	1936,-	2112,-	2233,-	2508,-	2640,-	2772,-	2970,-	3300,-	3630,-	4400,-	2112,-	2233,-	20	10	20	88	75
125	4	2178,-	2255,-	2332,-	2563,-	2728,-	2959,-	2750,-	3080,-	3300,-	3960,-			23	10	20	110	110
	5	2266,-	2387,-	2508,-	2728,-	2992,-	3256,-	2970,-	3300,-	3630,-	4400,-	2387,-	2508,-	23	10	20	110	106
	10	2420,-	2574,-	2783,-	3036,-	3454,-	3960,-	3300,-	3850,-	4400,-	5390,-	2574,-	2783,-	23	10	20	110	98
	15	2607,-	2838,-	3146,-	3432,-	4092,-	4620,-	3740,-	4510,-	5170,-	6820,-	2838,-	3176,-	23	10	20	110	88
150	5	2541,-	2684,-	2816,-	3091,-	3377,-	3696,-	2200,-	3850,-	4510,-	5500,-	2684,-	2816,-	23	10	20	135	131
	10	2717,-	2959,-	3201,-	3498,-	3982,-	4532,-	3740,-	4290,-	4950,-	6820,-	2959,-	3201,-	23	10	20	135	123
	15	3267,-	3498,-	3729,-	4312,-	5269,-	5544,-	4070,-	4840,-	5500,-	8580,-	3498,-	3729,-	23	10	20	135	113

Techcentrum s.r.o. Česká Třebová tel. 464 649 336

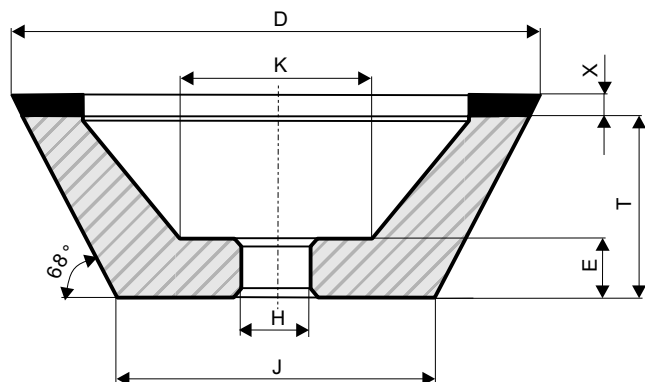

FEPA 11B2

D	W	PRYSKYŔIENÉ - DIAMANT			PRYSKYŔIENÉ - CBN			KERAMIKA DIA		KERAMIKA CBN		KOVOVÉ DIA			T	E	H	J	K
		X			X			X		X		X							
		2	3	4	2	3	4	3	5	3	5	1,5	2	3					
75	5	1155,-	1298,-	1331,-	1309,-	1573,-	1716,-	2200,-	2530,-	2420,-	2750,-				36	12	13	42	31
	10	1232,-	1375,-	1496,-	1584,-	1815,-	2057,-	2310,-	2750,-	2640,-	3300,-	1232,-	1375,-	1496,-	36	12	13	42	28
100	5	1749,-	1848,-	2178,-	2178,-	2310,-	2497,-	2530,-	2695,-	3080,-	3630,-				36	12	20	67	56
	10	1936,-	2112,-	2530,-	2431,-	2640,-	2772,-	2970,-	3300,-	3630,-	4400,-	1936,-	2112,-	2530,-	36	12	20	67	43
125	5	2255,-	2387,-	2508,-	2728,-	2992,-	3256,-	2970,-	3300,-	3630,-	4400,-				36	12	20	92	81
	10	2420,-	2574,-	2783,-	3060,-	3454,-	3960,-	3300,-	3850,-	4400,-	5390,-	2420,-	2574,-	2783,-	36	12	20	92	78

Techcentrum s.r.o. Česká Třebová tel. 464 649 336

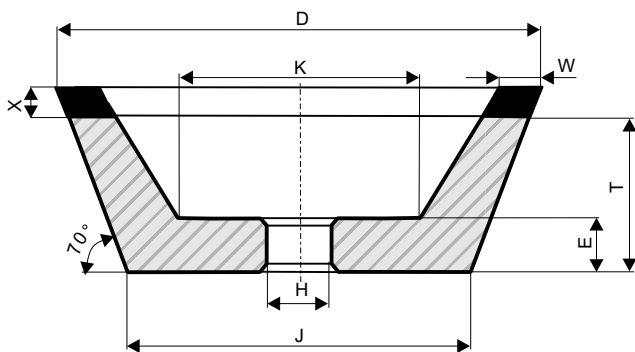

FEPA 11V2

D	W	PRYSKYŔIENÉ - DIAMANT			PRYSKYŔIENÉ - CBN			KERAMIKA DIA		KERAMIKA CBN		KOVOVÉ DIA			T	E	H	J	K
		X			X			X		X		X							
		2	3	4	2	3	4	3	5	3	5	2	3	4					
30	2	700,-	790,-	990,-	900,-	950,-	1100,-					700,-	790,-	990,-	15	8	10	15	14
40	2	900,-	1000,-	1100,-	1040,-	1190,-	1290,-					900,-	1000,-	1100,-	17	9	13	24	22
50	2	1000,-	1100,-	1200,-	1180,-	1300,-	1470,-					1000,-	1100,-	1200,-	20	9	13	37	35
75	4	1155,-	1260,-	1331,-	1270,-	1490,-	1650,-					1155,-	1260,-	1331,-	30	10	20	53	47
100	4	1749,-	2000,-	2170,-	2000,-	2300,-	2497,-					1749,-	2000,-	2170,-	30	10	20	78	72

Techcentrum s.r.o. Česká Třebová tel. 464 649 336

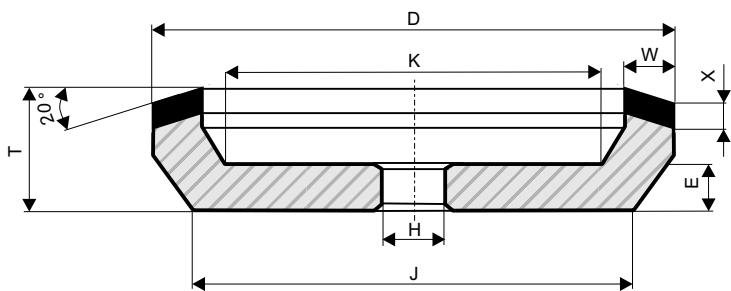

FEPA 11V5

D	W	PRYSKYŔIENÉ - DIAMANT			PRYSKYŔIENÉ - CBN			KERAMIKA DIA		KERAMIKA CBN		KOVOVÉ - DIA		T	E	H	J	K
		X			X			X		X		X						
		2	3	4	2	3	4	3	5	3	5	2	3					
75	3	1078,-	1100,-	1122,-	1265,-	1342,-	1430,-	2090,-	2420,-	2200,-	2530,-			20	10	13	63	64
	4	1100,-	1122,-	1155,-	1320,-	1419,-	1529,-	2145,-	2475,-	2310,-	2640,-			20	10	13	63	62
	5	1155,-	1232,-	1265,-	1419,-	1573,-	1716,-	2200,-	2530,-	2420,-	2750,-	1232,-	1265,-	20	10	13	63	58
	10	1287,-	1375,-	1441,-	1584,-	1826,-	2057,-	2310,-	2750,-	2640,-	3300,-	1375,-	1441,-	20	10	13	63	50
100	3	1639,-	1705,-	1771,-	1870,-	1980,-	2112,-	2310,-	2420,-	2640,-	3080,-			20	10	20	88	89
	4	1694,-	1749,-	1826,-	1980,-	2134,-	2299,-	2420,-	2530,-	2860,-	3300,-			20	10	20	88	87
	5	1749,-	1848,-	2178,-	2178,-	2310,-	2497,-	2530,-	2695,-	3080,-	3630,-	1848,-	2178,-	20	10	20	88	83
	10	1936,-	2112,-	2233,-	2508,-	2640,-	2772,-	2970,-	3300,-	3630,-	4400,-	2112,-	2233,-	20	10	20	88	75
125	4	2178,-	2255,-	2332,-	2563,-	2728,-	2959,-	2750,-	3080,-	3300,-	3960,-			23	10	20	110	110
	5	2266,-	2387,-	2508,-	2728,-	2992,-	3256,-	2970,-	3300,-	3630,-	4400,-	2387,-	2508,-	23	10	20	110	106
	10	2420,-	2574,-	2783,-	3036,-	3454,-	3960,-	3300,-	3850,-	4400,-	5390,-	2574,-	2783,-	23	10	20	110	98
	15	2607,-	2838,-	3146,-	3432,-	4092,-	4620,-	3740,-	4510,-	5170,-	6820,-	2838,-	3176,-	23	10	20	110	88
150	5	2541,-	2684,-	2816,-	3091,-	3377,-	3696,-	2200,-	3850,-	4510,-	5500,-	2684,-	2816,-	23	10	20	135	131
	10	2717,-	2959,-	3201,-	3498,-	3982,-	4532,-	3740,-	4290,-	4950,-	6820,-	2959,-	3201,-	23	10	20	135	123
	15	3267,-	3498,-	3729,-	4312,-	5269,-	5544,-	4070,-	4840,-	5500,-	8580,-	3498,-	3729,-	23	10	20	135	113

Techcentrum s.r.o. Česká Třebová tel. 464 649 336

FEPA 11V9

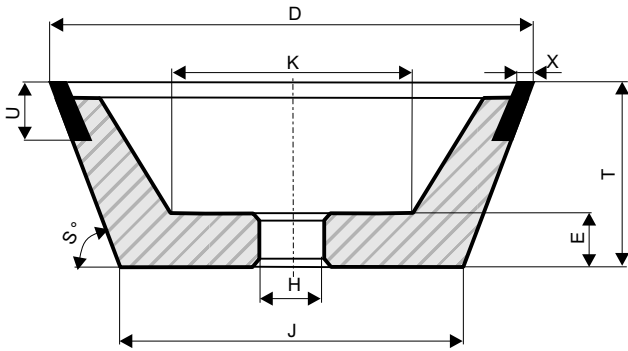

D	U	PRYSKY I NÉ - DIAMANT			PRYSKY I NÉ - CBN			KERAMIKA - DIAMANT			KERAMIKA - CBN			T	E	H	J	K	S°
		X			X			X			X								
		2	3	4	2	3	4	2	3	4	2	3	4						
50	6	847,-	880,-		880,-	908,-								25	10	10	31	27	70
60	9	968,-	1017,-		1067,-	1122,-								25	10	10	41	32	70
75	6	1155,-	1298,-		1309,-	1573,-								30	10	13	53	40	70
	9	1188,-	1331,-		1485,-	1639,-								25	10	20	57	36	70
	9	1188,-	1331,-		1485,-	1639,-								25	10	20	43	43	50
	10	1232,-	1375,-		1584,-	1815,-								30	10	13	53	40	70
100	6	1749,-	1848,-		2178,-	2310,-								35	10	20	75	55	70
	9	1870,-	1991,-		2431,-	2563,-								25	10	20	80	70	70
	9	1870,-	1991,-		2431,-	2563,-								25	10	20	65	65	50
	10	1935,-	2110,-		2508,-	2640,-								35	10	20	75	55	70
125	6	2255,-	2387,-		2728,-	2992,-								40	10	20	96	75	70
	10	2420,-	2574,-		3036,-	3454,-								40	10	20	96	75	70
150	6	2541,-	2684,-		3080,-	3377,-								50	10	20	114	90	70
	10	2717,-	2959,-		3498,-	3982,-								50	10	20	114	90	70

Techcentrum s.r.o. Česká Třebová tel. 464 649 336

FEPA 12A2

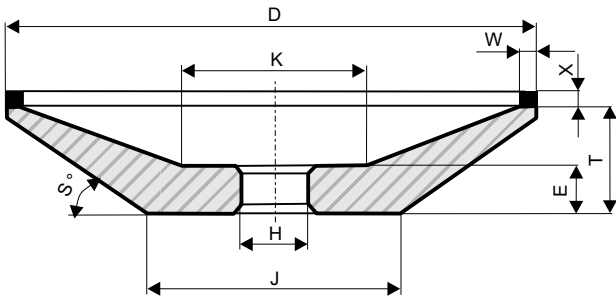

D	W	PRYSKYŮJENÉ - DIAMANT			PRYSKYŮJENÉ - CBN			KERAMIKA DIA		KERAMIKA CBN		KOVOVÉ - DIAMANT			T	E	H	J	K	S°
		X			X			X		X		X								
		3	4	5	3	4	5	3	5	3	5	3	4	5						
50	2	726,-	748,-	770,-	858,-	880,-	913,-	1089,-	1188,-	1221,-	1364,-				17	9	13	31	28	55
	3	748,-	770,-	792,-	902,-	935,-	968,-	1188,-	1364,-	1353,-	1595,-				17	9	13	31	28	55
75	2	1045,-	1078,-	1133,-	1276,-	1452,-	1551,-	1562,-	1661,-	1716,-	1826,-	1045,-	1078,-	1133,-	20	12,5	13	49	45	45
	3	1078,-	1100,-	1210,-	1342,-	1551,-	1639,-	2090,-	2420,-	2200,-	2530,-				22	10	13	43	40	45
	3	1078,-	1100,-	1210,-	1342,-	1551,-	1639,-	2090,-	2420,-	2200,-	2530,-				21	9	13	35	35	40
100	2	1573,-	1628,-	1683,-	1694,-	1980,-	2167,-	1925,-	2090,-	2200,-	2420,-	1573,-	1628,-	1683,-	20	12,5	20	74	70	45
	3	1694,-	1771,-	1870,-	1840,-	2178,-	2266,-	2310,-	2420,-	2640,-	3080,-				21	9	20	60	60	40
125	2	1936,-	2013,-	2090,-	2057,-	2376,-	2508,-	2200,-	2475,-	2640,-	2970,-	1936,-	2013,-	2090,-	25	12,5	20	89	78	45
	2	1936,-	2013,-	2090,-	2057,-	2376,-	2508,-	2200,-	2475,-	2640,-	2970,-	1936,-	2013,-	2090,-	22	12	20	80	84	38
	3	2156,-	2233,-	2310,-	2255,-	2629,-	2794,-	2530,-	2805,-	2970,-	3465,-	2156,-	2233,-	2310,-	25	12,5	20	80	84	45
	4	2255,-	2332,-	2420,-	2728,-	2959,-	3102,-	2750,-	3080,-	3300,-	3960,-	2255,-	2332,-	2420,-	25	12,5	20	80	84	45
150	2	2178,-	2266,-	2343,-	2882,-	3047,-	3223,-	2530,-	2970,-	3080,-	3520,-	2310,-	2431,-	2552,-	25	12,5	20	114	103	45
	2	2178,-	2266,-	2343,-	2882,-	3047,-	3223,-	2530,-	2970,-	3080,-	3520,-	2310,-	2431,-	2552,-	27	12	20	90	68	35
	3	2277,-	2398,-	2640,-	3047,-	3344,-	3630,-	2750,-	3300,-	3740,-	4400,-	2431,-	2563,-	2805,-	25	12,5	20	114	100	45

Techcentrum s.r.o. Česká Třebová tel. 464 649 336

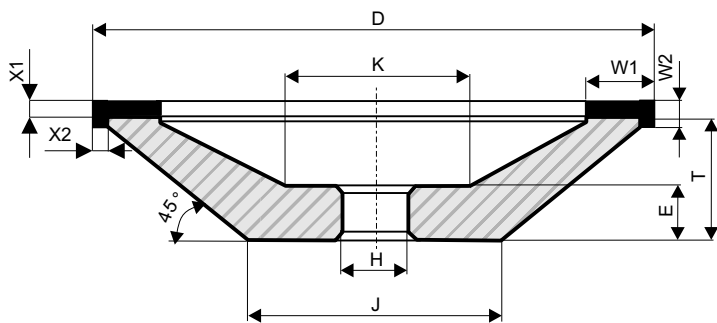

FEPA 12C9

D	W1	W2	PRYSKYŔIENÉ - DIAMANT		PRYSKYŔIENÉ - CBN		T	E	H	J	K
			X1	X2	X1	X2					
			2	2	2	2					
75	10	4		1560,-		2265,-	20	10	13	37	37
	10	10		2090,-		3030,-	20	10	13	37	37
100	10	4		2500,-		3625,-	23	10	20	56	54
	10	10		2915,-		4226,-	23	10	20	56	54
125	10	4		3990,-		5785,-	23	10	20	81	71
	10	10		3520,-		5104,-	23	10	20	81	71
150	10	4		2959,-		4290,-	23	10	20	106	96
	10	10		3990,-		5785,-	23	10	20	106	96
	15	5		3970,-		5756,-	23	10	20	106	96

Techcentrum s.r.o. Česká Třebová tel. 464 649 336

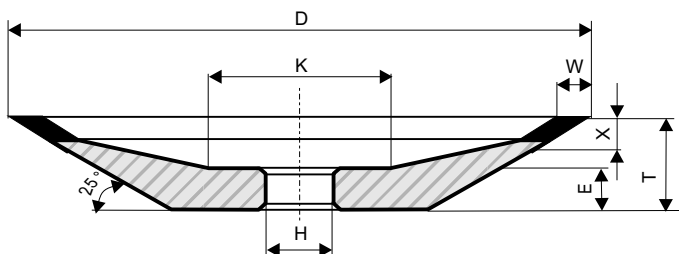

FEPA 12R4

D	W	PRYSKYŔIENÉ - DIAMANT			PRYSKYŔIENÉ - CBN			KERAMIKA - DIAMANT			KERAMIKA - CBN			T	E	H
		X			X			X			X					
		2	3	4	2	3	4	2	3	4	2	3	4			
75	2		1298,-			1573,-								10	6	13
	2		1848,-			2310,-								10	6	20
100	3		1900,-			2510,-								10	6	20
	2		2387,-			2992,-								12	8	20
125	3		2432,-			2254,-								12	8	20
	4		2574,-			3454,-								12	8	20
150	3		2684,-			3377,-								16	9	20
	5		2959,-			3982,-								16	9	20

Techcentrum s.r.o. Česká Třebová tel. 464 649 336

FEPA 12V2

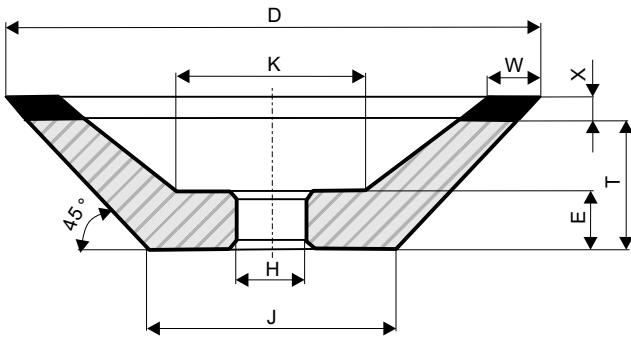

D	W	PRYSKYŮŽIĚNÉ - DIAMANT			PRYSKYŮŽIĚNÉ - CBN			KERAMIKA DIA		KERAMIKA CBN			KOVOVÉ DIA			T	E	H	J	K
		X			X			X		X			X							
		2	3	4	2	3	4	3	5	3	5	1,5	2	3						
75	5	1155,-	1298,-	1331,-	1309,-	1573,-	1650,-	2200,-	2530,-	2420,-	2750,-				18	10	13	33	33	
	10	1232,-	1375,-	1496,-	1584,-	1815,-	2057,-	2310,-	2750,-	2640,-	3300,-	1232,-	1375,-	1496,-	18	10	13	33	33	
100	5	1749,-	1848,-	2178,-	2178,-	2310,-	2497,-	2530,-	2695,-	3080,-	3630,-				23	10	20	46	46	
	10	1936,-	2112,-	2530,-	2431,-	2970,-	2772,-	2970,-	3300,-	3630,-	4400,-	1749,-	2112,-	2530,-	23	10	20	46	46	
125	5	2255,-	2387,-	2508,-	2728,-	2992,-	3256,-	2970,-	3300,-	3630,-	4400,-				23	10	20	71	71	
	10	2717,-	2574,-	2783,-	3036,-	3454,-	3960,-	3300,-	3850,-	4400,-	5390,-	2420,-	2574,-	2783,-	23	10	20	71	71	
150	5	2541,-	2684,-	2816,-	3080,-	3377,-	3696,-	3300,-	3850,-	4510,-	5500,-				23	12	20	96	100	
	10	2717,-	2959,-	3190,-	3498,-	3982,-	4532,-	3740,-	4290,-	4950,-	6820,-	2717,-	2959,-	3190,-	23	12	20	96	100	

Techcentrum s.r.o. Česká Třebová tel. 464 649 336

FEPA 12V9

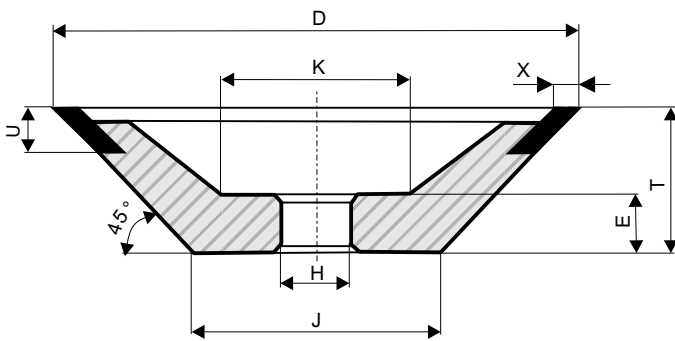

D	U	PRYSKYŮŽIĚNÉ - DIAMANT			PRYSKYŮŽIĚNÉ - CBN			KERAMIKA - DIAMANT			KERAMIKA - CBN			T	E	H	J	K
		X			X			X			X							
		2	3	4	2	3	4	2	3	4	2	3	4					
50	6	847,-	880,-		880,-	908,-								20	10	10	30	20
60	9	968,-	1017,-		1067,-	1122,-								20	10	10	32	30
75	6	1155,-	1298,-		1309,-	1573,-								20	10	13	35	45
	9	1188,-	1331,-		1485,-	1639,-								20	10	20	35	45
	9	1188,-	1331,-		1485,-	1639,-								20	10	20	35	45
	10	1232,-	1375,-		1584,-	1815,-								20	10	13	35	45
100	6	1749,-	1848,-		2178,-	2310,-								20	10	20	60	65
	9	1870,-	1991,-		2431,-	2563,-								20	10	20	60	65
	9	1870,-	1991,-		2431,-	2563,-								20	10	20	60	65
	10	1935,-	2110,-		2508,-	2640,-								20	10	20	60	65
125	6	2255,-	2387,-		2728,-	2992,-								25	10	20	75	80
	10	2420,-	2574,-		3036,-	3454,-								25	10	20	75	80
150	6	2541,-	2684,-		3080,-	3377,-								25	10	20	100	105
	10	2717,-	2959,-		3498,-	3982,-								25	10	20	100	105

Techcentrum s.r.o. Česká Třebová tel. 464 649 336

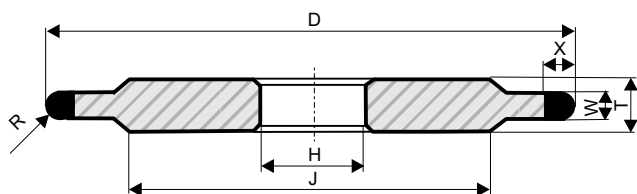

FEPA 14F1

D	W	PRYSKYŔIENÉ - DIAMANT				PRYSKYŔIENÉ - CBN			KERAMIKA DIA		KERAMIKA CBN		KOVOVÉ - DIAMANT			
		X				X			X		X		R	T	H	J
		2	3	6	2	3	6	5	10	5	10					
75	2	891,-			1001,-			1320,-		1650,-			1	6	13	50
	3	919,-	946,-		1095,-	1172,-		1540,-		1980,-			1,5	6	13	50
	4		1012,-	1056,-		1282,-	1518,-	1760,-		2310,-			2	6	13	50
	5		1111,-	1199,-		1441,-	1815,-	1980,-		2530,-			2,5	6	13	50
	6			1364,-		1969,-	2200,-	2200,-		2750,-			3	6	13	50
100	2	990,-			1084,-			1430,-		1870,-			1	8	20	70
	3	1029,-	1150,-		1111,-	1573,-		1650,-		2090,-			1,5	8	20	70
	4		1172,-	1837,-		1650,-	2668,-	1870,-		2420,-			2	8	20	70
	5		1958,-	2019,-		1925,-	2904,-	2090,-		2640,-			2,5	8	20	70
	6			2299,-		3168,-	2310,-	2860,-		2860,-			3	8	20	70
125	2	1111,-			1216,-			1760,-		2200,-			1	8	20	100
	3	1188,-	1716,-		1298,-	2008,-		1925,-		2475,-			1,5	8	20	100
	4		1837,-	2079,-		2244,-	2981,-	2090,-		2750,-			2	8	20	100
	5		2299,-	2321,-		2508,-	3141,-	2145,-		3025,-			2,5	8	20	100
	6			2409,-		3300,-	2420,-	3300,-		3300,-			3	8	20	100
150	2	1331,-			1430,-			2090,-		2640,-			1	10	20	120
	3	1513,-	1958,-		1540,-	2431,-		2255,-		3080,-			1,5	10	20	120
	4		2046,-	2288,-		2970,-	3157,-	2420,-		3520,-			2	10	20	120
	5		2430,-	2563,-		3168,-	3498,-	2585,-		3960,-			2,5	10	20	120
	6			2662,-		3850,-	2750,-	4400,-		4400,-			3	10	20	120

Techcentrum s.r.o. Česká Třebová tel. 464 649 336

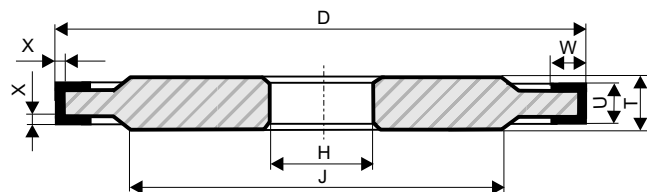

FEPA 14U1

D	U	PRYSKYŔIENÉ - DIAMANT				PRYSKYŔIENÉ - CBN				KOVOVÉ - DIAMANT				X	T	H	J
		W				W				W							
		4	6	8	10	4	6	8	10	4	6	8	10				
75	5	2340,-	2380,-	2410,-	2460,-	3393,-	3451,-	3494,-	3567,-	2380,-	2410,-	2460,-	2500,-	2	9	13	40
	6	2390,-	2430,-	2470,-	2510,-	3465,-	3523,-	3581,-	3639,-	2430,-	2470,-	2510,-	2550,-	2	10	13	40
	8	2430,-	2490,-	2520,-	2559,-	3523,-	3610,-	3654,-	3710,-	2490,-	2520,-	2559,-	2639,-	2	12	13	40
100	6	2560,-	2600,-	2690,-	2830,-	3712,-	3770,-	3900,-	4103,-	2600,-	2690,-	2830,-	2870,-	2	10	20	50
	8	2690,-	2770,-	2850,-	2980,-	3900,-	4016,-	4132,-	4321,-	2770,-	2850,-	2980,-	3020,-	2	12	20	50
	10	2800,-	2880,-	2940,-	2999,-	4060,-	4176,-	4263,-	4348,-	2880,-	2940,-	2999,-	3060,-	2	14	20	50
	15	3550,-	3630,-	3690,-	3750,-	5147,-	5263,-	5350,-	5437,-	3630,-	3690,-	3750,-	3810,-	2	19	20	50
125	6	2975,-	3130,-	3250,-	3400,-	4314,-	4538,-	4712,-	4930,-	3130,-	3250,-	3400,-	3520,-	2	10	20	65
	8	3120,-	3250,-	3320,-	3490,-	4524,-	4712,-	4814,-	5060,-	3250,-	3320,-	3490,-	3600,-	2	12	20	65
	10	3300,-	3410,-	3490,-	3570,-	4785,-	4944,-	5060,-	5176,-	3410,-	3490,-	3570,-	3690,-	2	14	20	65
150	6	3080,-	3230,-	3410,-	3590,-	4465,-	4683,-	4944,-	5205,-	3230,-	3410,-	3590,-	3710,-	2	10	20	80
	8	3250,-	3480,-	3630,-	3770,-	4712,-	5046,-	5263,-	5466,-	3480,-	3630,-	3770,-	3850,-	2	12	20	80
	10	3500,-	3610,-	3790,-	3950,-	5075,-	5234,-	5495,-	5727,-	3610,-	3790,-	3950,-	4170,-	2	14	20	80
175	6	3690,-	3850,-	4090,-	4220,-	5350,-	5582,-	5930,-	6119,-	3850,-	4090,-	4220,-	4350,-	2	10	32	100
	8	3830,-	3980,-	4200,-	4380,-	5553,-	5771,-	6090,-	6351,-	3980,-	4200,-	4380,-	4500,-	2	12	32	100
	10	3900,-	4050,-	4320,-	4535,-	5655,-	5872,-	6265,-	6576,-	4050,-	4320,-	4535,-	4640,-	2	14	32	100
200	8	4710,-	4860,-	5000,-	5150,-	6829,-	7047,-	7250,-	7467,-	4860,-	5000,-	5150,-	5300,-	2	14	32-76	120
	10	5350,-	5500,-	5660,-	5800,-	7757,-	7975,-	8207,-	8410,-	5500,-	5660,-	5800,-	5940,-	2	16	32-76	120
	12	5800,-	6000,-	6190,-	6300,-	8410,-	8700,-	8975,-	9135,-	6000,-	6190,-	6300,-	6410,-	2	18	32-76	120

Techcentrum s.r.o. Česká Třebová tel. 464 649 336